

# Harena 12

 09.05.112 MA





<p> <b>ACHTUNG:</b> Lesen Sie die gesamte Montageanleitung aufmerksam durch, bevor Sie mit der Montage beginnen! Ziehen Sie die Schrauben erst fest, wenn die gesamte Einheit zusammen gestellt ist. Beachten Sie beiliegenden Fundamentplan. Das Gerät darf erst nach vollständigem Abbinden der Fundamente zur Nutzung freigegeben werden (mind. 5 Tage)! Vor der Freigabe des Geräts unbedingt ALLE Schraubverbindungen auf Festigkeit prüfen und unbedingt Sicher stellen, dass sämtliche Montagehilfsmittel vom Gerät entfernt wurden!</p>	<p> <b>ATTENTION:</b> Read the entire installation instructions carefully before starting installation! Tighten the screws only fixed when the entire unit is put together. Note accompanying the foundation plan. The device may be released for use only after complete setting of the foundations (min. 5 days)! Absolutely ALL screw before the release of the device on strength and absolutely ensure that all assembly aids have been removed from the device!</p>	<p> <b>ATTENTION:</b> Lisez les instructions d'installation entières soigneusement avant de commencer l'installation! Serrer les vis fixes uniquement lorsque l'ensemble de l'unité est mis en place. Remarque accompagnant le plan de fondation. Le dispositif peut être libéré pour une utilisation seulement après la prise complète des fondations (min. 5 jours)! Absolument vis ALL Avant la sortie de l'appareil sur la force et absolument veiller à ce que toutes les aides d'assemblage ont été retirés de l'appareil!</p>	<p> <b>ATENCIÓN:</b> Leer las instrucciones antes de comenzar la instalación. Apretar los tornillos fijos únicamente cuando la estructura esté totalmente ensamblada. Se acompaña plano de cimentación. Asegurarse de que los cimientos de hormigón están suficientemente endurecido antes del primer uso. (min. 5 días) Asegurarse de que se eliminan todos los auxiliares de montaje antes de usar!</p>	<p> <b>OPREZ:</b> Pročitajte čitavu instalaciju upute pažljivo prije pokretanja instalacije! Stegnite vijke fiksne tek kada je cijela jedinica je staviti zajedno. Napomena prateći plan temelj. Uređaj se može pustiti u upotrebu samo nakon potpunog postavljanje temelja (min. 5 dana)! Apsolutno SVE vijak Prije puštanja uređaja na snagu i apsolutno bi se osiguralo da su sve preinake koje pomagala su uklonjene iz uređaja!</p>	<p> <b>ΠΡΟΣΟΧΗ:</b> Διαβάστε ολόκληρο οδηγίες εγκατάστασης προσεκτικά πριν ξεκινήσετε την εγκατάσταση! Σφίξτε τις βίδες σταθερό μόνο όταν ολόκληρη η μονάδα είναι μαζί. Σημείωμα που συνοδεύει το σχέδιο θεμελίωσης. Η συσκευή μπορεί να απελευθερωθεί για χρήση μόνο μετά την πλήρη ρύθμιση της θεμέλια (min. 5 ημέρες)! απολύτως όλα βίδα Πριν από την κυκλοφορία της συσκευής στην αντοχή και απόλυτα διασφαλίσει ότι όλα τα βοηθήματα συναρμολόγησης έχουν αφαιρεθεί από τη συσκευή!</p>	<p> <b>ВНИМАНИЕ:</b> Прочети цялата инструкции за инсталиране внимателно преди започване на инсталация! Затегнете винтовете фиксирани само когато целият блок се поставя заедно. Имайте предвид, придружаваща плана за фундамент. Устройството може да бъде пуснато в употреба само след пълна настройка на основи (мин. 5 дни)! абсолютно всички винтови Преди пускането на устройството на сила и абсолютно гарантира, че всички монтажни помощи са били отстранени от устройството!</p>	<p> <b>DIKKAT:</b> Kurulumu başlamadan önce dikkatlice tüm kurulum talimatlarını okuyun! Tüm birim araya vidaları sıkın. Vakıf planı eşlik edin. Cihaz sadece temelleri tam ayarında sonra kullanılmak üzere serbest bırakılabilir (min. 5 gün)! kesinlikle TÜM gücüne cihazın yayımlanmasından önce vida ve kesinlikle tüm montaj yardımcılarını cihazdan çıkarıldıktan emin olun!</p>
<p> <b>ATTENZIONE:</b> Leggere l'intero istruzioni di installazione prima di iniziare l'installazione! Serrare le viti di fissaggio solo quando l'intera unità è messo insieme. Si noti che accompagna il piano di fondazione. Il dispositivo può essere rilasciato per l'uso solo dopo l'impostazione completa della fondamenta (min. 5 giorni)! assolutamente TUTTO vite prima del rilascio del dispositivo sulla forza e assolutamente garantire che tutti gli aiuti di assemblaggio sono stati rimossi dal dispositivo!</p>	<p> <b>VARNING:</b> Läs hela monteringsanvisningen noga innan monteringen påbörjas! Dra åt skruvarna endast fasta när hela enheten sätts ihop. Observera medföljande grunden planen. Enheten får övergå till bruk efter fullständig inställning av fundament (min. 5 dagar)! absolut alla skruv före utgivningen av enheten på styrka och absolut se till att alla monteringshjälp har tagits bort från enheten!</p>	<p> <b>POZOR:</b> Natančno preberite celotna navodila za namestitev pred začetkom nameščanja! Privijte vijake fiksne šele, ko je celotna enota skupaj. Opomba priložen načrt temelj. Naprava se lahko sprosti za uporabo šele po popolni nastavitvi fundacij (min. 5 dni)! absolutno VSE vijak pred sprostitvijo naprave na moč in absolutno zagotovi, da so bili vsi sestavljanja pomagala odstraniti iz naprave!</p>	<p> <b>ATENȚIE:</b> Citiți instrucțiunile de instalare întregi cu atenție înainte de a începe instalarea! Strângeți șuruburile numai fixe atunci când întreaga unitate este pus împreună. Notă care însoțește planul de fundație. Dispozitivul poate fi eliberat pentru a fi utilizate numai după setarea completă a fundațiilor (min. 5 zile)! absolut toate celelalte șuruburi înainte de lansarea dispozitivului pe forță și să se asigure că absolut toate ajutoarele de asamblare au fost scoase din aparat!</p>	<p> <b>LET OP:</b> Lees de installatie-instructies zorgvuldig door voordat u begint met de montage. Draai de schroeven pas volledig vast wanneer het toestel geheel is gemonteerd. Leest u het bijgeleverde montageplan aandachtig door. Het toestel kan pas vrijgegeven worden voor gebruik na de volledige uitharding van de fundatie. (minimaal 5 dagen). Voordat het toestel wordt vrijgegeven dient u nogmaals alle schroefverbindingen zorgvuldig te controleren en zo nodig vast te draaien. Verwijder alle montagehulpmiddelen van het toestel voor gebruik.</p>	<p> <b>ADVARSEL:</b> Læs hele installationsvejledningen omhyggeligt inden installation! Spænd skruerne kun faste, når hele enheden er sat sammen. Bemærk ledsager fundamentet planen. Enheden kan frigives til brug efter fuldstændig indstilling af fundamenter (min. 5 dage)! absolut ALLE skruer Før udgivelsen af enheden på styrke og absolut sikre, at alle montage hjælpemidler er blevet fjernet fra enheden!</p>	<p> <b>FORSIKTIG:</b> Les hele installasjonsveiledningen nøye før du starter installasjonen! Stram skruene bare faste når hele enheten er satt sammen. Merkfølger grunnlaget plan. Enheten kan bli frigitt for bruk kun etter fullstendig innstilling av fundamenter (min. 5 dager)! absolutt ALLE skruer Før utgivelsen av enheten på styrke og absolutt sikre at alle monteringshjelpemidler er fjernet fra enheten!</p>	<p> <b>VAROITUS:</b> Lue koko asennusohje huolellisesti ennen asennuksen aloittamista! Kiristä ruuvit vain kiinteä, kun koko laite on koottu. Huomaa mukana perusta suunnitelma. Laite voidaan luovuttaa käyttöön vasta sen jälkeen, kun täydellinen asetus perustusten (min. 5 päivää)! ehdottomasti KAIKKI ruuvi Ennen vapauttamista laitteeseen vahvuus ja ehdottomasti varmistettava, että kaikki kokoonpanon tuet on poistettu laitteesta!</p>



# Harena 12



<p><b>UWAGA:</b> Przeczytać całą instrukcję instalacji uważnie przed rozpoczęciem instalacji! Dokręcić śruby tylko stałe, kiedy całe urządzenie jest połączone. Uwaga towarzyszące plan fundamentu. Urządzenie może być dopuszczane do użytku dopiero po całkowitym otoczeniu fundamentów (min. 5 dni)! absolutnie przykręcić Przed zwolnieniem urządzenia na wytrzymałość i całkowicie zapewnić, że wszystkie środki wspomagające montaż zostały usunięte z urządzenia!</p>	<p><b>VIGYÁZAT:</b> Olvassa el a teljes telepítési utasításokat a telepítés megkezdése előtt! Húzza meg a csavarokat csak meghatározni, ha az egész egységet össze. Megjegyzés kísérő alapozási tervet. Az eszköz felszabadítható csak teljes rögzítése alapjait (min. 5 nap)! abszolút minden csavar felszabadítása előtt, a berendezés szilárdsága és teljesen arról, hogy szerelési segédesszközöket már eltávolították a készüléket!</p>	<p><b>POZOR:</b> Přečíst celý návod k instalaci informací dříve, než zahájením instalace! Utáhnout šrouby fixní pouze tehdy, když je celý přístroj dohromady. Všimněte si, doprovázející Plan Foundation. Zařízení může být uvolněna k použití teprve po úplném nastavení základů (min. 5 dní)! naprosto všechny šroubové Před uvolněním zařízení na pevnost a zcela zajistit, aby všechny montážní pomůcky byly odstraněny ze zařízení!!</p>	<p><b>CUIDADO:</b> Leia as instruções de instalação inteira cuidadosamente antes de iniciar a instalação! Apertar os parafusos única fixos quando toda a unidade é colocada em conjunto. Nota que acompanha o plano de fundação. O dispositivo pode ser liberado para uso somente após a definição completa do fundações (min. 5 dias)! absolutamente todos os parafusos Antes do lançamento do dispositivo sobre a força e absolutamente assegurar que todos os auxiliares de montagem ter sido removido do dispositivo de!</p>
--	--	---	--

	Platzbedarf	Fallraum	Max. freie Fallhöhe	Gesamthöhe	Empfohlene Altersgruppe	Fundamente	schwerstes Teil/ Gesamtgewicht	Lieferumfang	Packmaße
	Space requirement	Impact area	Free fall height	Total height	Recommended age group	foundations	Heaviest part/ Total weight	Scope of delivery	Packing measures
	Espace requis	Cas de l'espace	Hauteur de chute	Hauteur totale	Groupe d'âge recommandée	Fondations	Partie plus lourde	Contenu de la livraison	Mesures d'emballage
	Espacio requerido	área de impacto	Altura de caída	Altura total	Grupo de edad recomendado	Fundamentos	Parte más pesada	Volumen de suministro	Medidas de embalaje
	Requisiti di spazio	Spazio case	Altezza di caduta	Altezza totale	Gruppo d'età consigliata	Fondazioni	Più pesante	Dotazione di forniture	Misure dell'imballaggio
	Rörelse område	Stötdämpande underlag	Fri fallhöjd	Total höjd	Rekomenderad åldersgrupp	Fundament	Tyngst del	Leveransomfattning	Förpackning åtgärder
	Prostorskih zahtev	primeru prostora	prosta višina padca	Skupna višina	priporočen starostni skupini	Temelje	Najtežji del	Obseg dobave	Pakiranje ukrepi
	Cerintele spațiului	Suprafața de impact	Înălțimea de cadere	Înălțimea totală	Grupa de vârstă recomandată	Fundații	Cea mai grea piesă	Scopul livrării	Măsurile de ambalare
	Vrije ruimte / afmeting speeltoestel	Obstakel vrije ruimte	Valhoogte	Totale hoogte	Leeftijdscategorie	Stichtingen	Zwaarste deel	Levertijd	Maatregelen van de verpakking
	Pladskravene	Indvirkning område	Fri højde af fald	Total højde	Anbefalet aldersgruppe	Fundamenter	tungeste del	Anvendelsesområdet for levering	Pakning foranstaltninger
	Arealkrav	Sikkerhetsareal	Fallhøyde	Totalhøyde	Aldersgruppe	Fundament	Tyngste delen	Leveranseomfang	Pakking tiltak
	Tilantarve	Lasku puhdistuma	Vapaa korkeus Fall	Korkeus yhteensä	Suosittelut ikäryhmässä	Säätiöt	Rankin kohta	Toimitukseen	Pakkaus toimenpiteet
	Wymagania dotyczące miejsca	Upadek luzu	Wolna wysokość upadku	Całkowita wysokość	Zalecany Wiek grupy	Fundacje	Najcięższe części	Zakres dostawy	Pakowania środków
	Helyigény	Őszén-szabadtér	Ingyenes esési magasság	Teljes magassága	Ajánlott korosztály	Alapítványok	legnehezebb része	A szállítási csomag része	Csomagolás intézkedések
	případ prostoru ...	případ prostoru	volná výška pádu	Celková výška	Doporučená věková skupina	Základy	Najtežší část	Rozsah dodávky	Balení opatření
	Requisitos de espaço	caso do espaço	Altura livre de queda	Altura total	Faixa etária recomendada	Fundações	Parte mais pesada	Escopo de fornecimento	Medidas da embalagem
	potreba za prostorom	Jesen klirens	Najviše slobodnog pada visine	Ukupna visina	preporučene dobne skupine	Zaklada	najteži dio/ Ukupna težina	Opseg isporuke	Pakiranje mjeregije
	Απαιτήσεις χώρου	Απόσταση από το φθινόπωρο	το ελεύθερο ύψος της πτώσης	Συνολικό ύψος	Συνιστώμενη ηλικιακή ομάδα	Θεμέλια	βαρύτερο μέρος	Έκταση παράδοσης	Συσκευασία μέτρα
	Пространствени изисквания	Падането клирънс	Свободно пространство с височина на падане	Обща височина	Препоръчителна възрастова група	Фондации	най-тежката част	Обхват на доставка	Мерки за опаковане
	Alan gereksinimleri	Sonbahar Gümrükleme	sonbaharın ücretsiz yüksekliği	Toplam yükseklik	Önerilen yaş grubu	Vakıflar	En ağır bölümü	Teslimat kapsamı	Ambalaj önlemler

?

PLAYPARC

PLAYPARC

PLAYPARC Allwetter-Freizeit-Anlagenbau GmbH  
 Zur Kohlstätte 9 · D-33014 Bad Driburg  
 Tel. +49 (0) 52 53 4 05 99-0 · Fax +49 (0) 52 53 4 05 99-10  
 info@playparc.de  
 www.playparc.de

# Harena 12

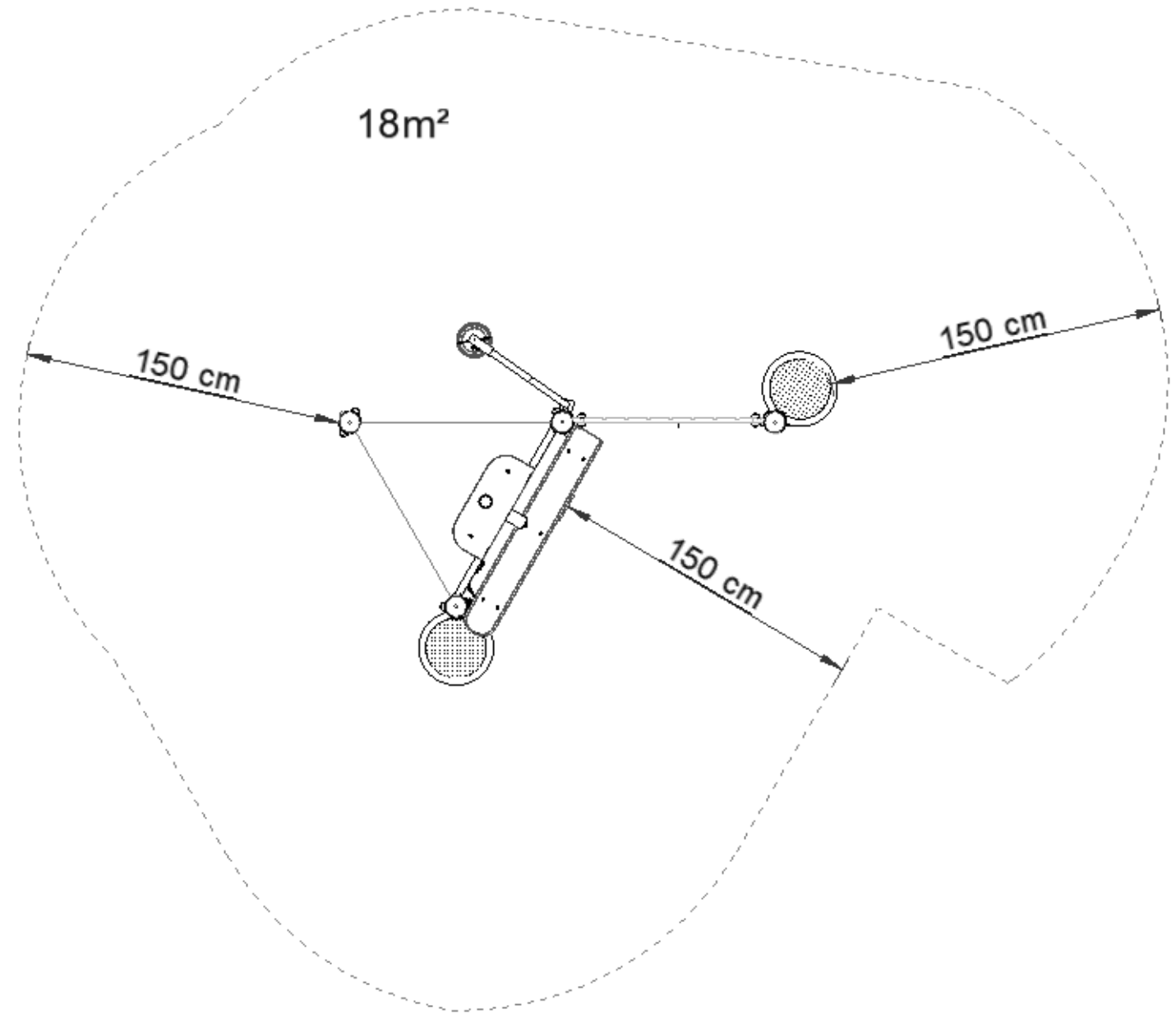
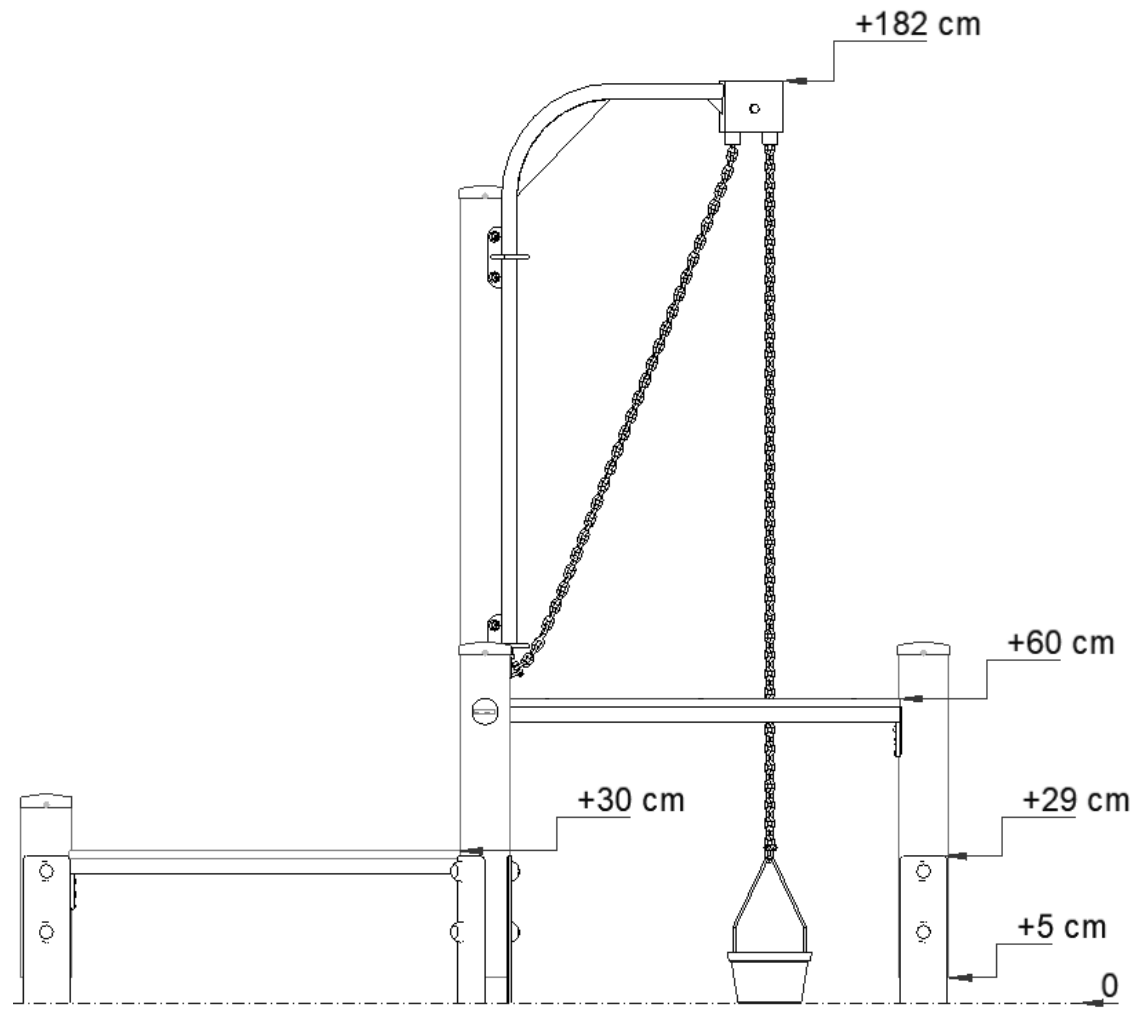

-  1,83x1,58x1,82 (m)

---

-  4,83x4,50 (m)

---

-  0,6 (m)

---

-  1,82 (m)

---

-  4x40x40x40 (cm)  
0,26 m<sup>3</sup> Concrete C25/30

---

-  0-4

---

-  ~14 kg / ~85 kg

---

-  3,10x1,20x0,50 (m)

# Harena 12



09.05.112 MA

NR.	Bild / Image	Menge / Quantity	Artikel / Article		Artikelnummer / Article number
		1	Harena Sandaufzug 2,5m Kette	Harena sand crane 2,5m Chain	0025470
		3	Pfostenabdeckkappe rot	Post cover red	2511080
		1	Playparc Plakette	Playparc plaque	1801001
		1	Brüstung weiß		0025304
		2	Sandsieb	sand sieve	0025461
		1	Sand Schaufel	sand shovel	0025186
		4	Pfostenschuh 100Ø	Postshoe 100Ø	0025101

NR.	Bild / Image	Menge / Quantity	Artikel / Article		Artikelnummer / Article number
		4	Universalwinkel Pfosten	Universal angle	8108125
		8	Schraubenabdeckung gerade	flat screw cover	2511093
		41	Pfostenschraube 8x50mm T40	Postscrew 8x50mm T40	1828052
		10	Unterlegscheibe DIN 125 M10 VA	Washer DIN 125 M10 VA	1827013
22		16	Unterlegscheibe M8 PA	Counter washer M8 PA	1828051
21		16	Pfostenschraube 8x50mm T40	Postscrew 8x50mm T40	1828052
		2	SENKSCHRAUBE MIT INNENSECHSKANT M10X30 EDELSTAHL, DIN7991	COUNTERSUNK SCREW M10X30 STAINLESS STEEL, DIN7991	1807029
		2	Würth_0348010_DIN_986 Edelstahl_A2_70_blank_15.stp	Würth_0348010_DIN_986 stainless steel_A2_70_blank_15.stp	1880027
		32	Unterlegscheibe M8 PA	Counter washer M8 PA	1828051
		4	Linsenkopfschraube ISO 7380 M10x35 A2	Pan head ISO 7380 M10x35 A2	1888005
		4	Sechskantmutter DIN 985 M10 VA	Hexagon nut DIN 985 M10 VA	1880026
		6	Linsenflanschschaube M8x25, VA	Lens flange screw M8x25, VA	1880097
		6	Würth_034808_DIN_986_Edelstahl_A2_70_blank_13.stp	Würth_034808_DIN_986 stainless steel_A2_70_blank_13.stp	1880043
		6	Würth_0409008_DIN_125_Edelstahl_A2_140_HV_blank_13.stp	Würth_0409008_DIN_125 stainless steel_A2_140_HV_blank_13.stp	1827009
26		8	GRV M10x80	Threadroll M10x80	1609042
27		16	Schraubenabdeckung rund Ø100mm	Screwcover curved Ø100mm	2511047
28		16	Unterlegscheibe DIN 125 M10 VA	Washer DIN 125 M10 VA	1827013
29		16	Linsenkopfschraube ISO 7380 M10x35 A2	Pan head ISO 7380 M10x35 A2	1888005

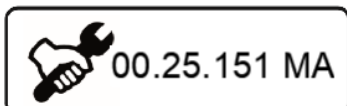

00.25.151 MA

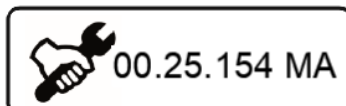

00.25.154 MA

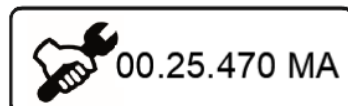

00.25.470 MA

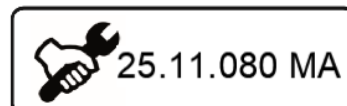

25.11.080 MA



# Harena 12

